

Trench Field-Stop Technology IGBT

Features

- 1200V, 40A
- $V_{CE(sat)(typ.)} = 1.6V @ V_{GE} = 15V, I_C = 40A$
- Low Switching Losses
- $V_{CE(sat)}$ with Positive Temperature Coefficient
- Pb-free Lead Plating; RoHS Compliant

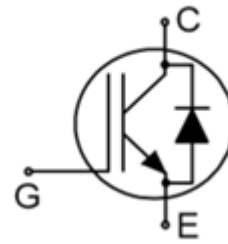

Applications

- Frequency Converters
- Uninterrupted Power Supply
- Air Conditioning
- Motor Drives

Order codes	V_{CE}	I_C	$V_{CEsat}, T_{vj}=25^{\circ}C$	T_{vjmax}	Marking	Package
XD040H120AT1S3	1200V	40A	1.6V	150 $^{\circ}C$	D40H120AT1	TO247-3

Absolute Maximum Ratings

Symbol	Parameter	Value	Unit
V_{CES}	Collector-Emitter Voltage	1200	V
V_{GES}	Gate-Emitter Voltage	± 20	V
I_C	Continuous Collector Current ($T_C=25^{\circ}C$)	80	A
	Continuous Collector Current ($T_C=100^{\circ}C$)	40	A
I_{CM}	Pulsed Collector Current (Note 1)	160	A
I_F	Diode Continuous Forward Current ($T_C=100^{\circ}C$)	40	A
I_{FM}	Diode Maximum Forward Current (Note 1)	80	A
t_{sc}	Short Circuit Withstand Time	10	us
P_D	Maximum Power Dissipation ($T_C=25^{\circ}C$)	394	W
	Maximum Power Dissipation ($T_C=100^{\circ}C$)	197	W
T_J	Operating Junction Temperature Range	-40 to 175	$^{\circ}C$
T_{STG}	Storage Temperature Range	-40 to 125	$^{\circ}C$

Thermal Data

Symbol	Parameter	Max.	Unit
$R_{\theta JC}$	Thermal Resistance, Junction to Case for IGBT	0.38	$^{\circ}C/W$

Electrical Characteristics ($T_c=25^{\circ}\text{C}$ unless otherwise noted)

Symbol	Parameter	Conditions	Min.	Typ.	Max.	Unit	
BV_{CES}	Collector-Emitter Breakdown Voltage	$V_{GE}=0V, I_C=500\mu A$	1200	---	---	V	
I_{CES}	Collector-Emitter Leakage Current	$V_{CE}=1200V, V_{GE}=0V$	---	---	1	mA	
I_{GES}	Gate Leakage Current, Forward	$V_{GE}=20V, V_{CE}=0V$	---	---	200	nA	
	Gate Leakage Current, Reverse	$V_{GE}=-20V, V_{CE}=0V$	---	---	-200	nA	
$V_{GE(th)}$	Gate Threshold Voltage	$V_{GE}=V_{CE}, I_C=0.5mA$	4.8	---	6.2	V	
$V_{CE(sat)}$	Collector-Emitter Saturation Voltage	$V_{GE}=15V, I_C=40A$	---	1.6	---	V	
Q_G	Total Gate Charge	$V_{CC}=960V, V_{GE}=15V$ $I_C=40A$	---	206	---	nC	
$t_{d(on)}$	Turn-on Delay Time	$V_{CC}=600V$ $V_{GE}=\pm 15V$ $I_C=40A$ $R_G=12\Omega$ Inductive Load $T_C=25^{\circ}\text{C}$	---	84	---	ns	
t_r	Turn-on Rise Time		---	50	---	ns	
$t_{d(off)}$	Turn-off Delay Time		---	264	---	ns	
t_f	Turn-off Fall Time		---	203	---	ns	
E_{on}	Turn-on Switching Loss		---	2.50	---	mJ	
E_{off}	Turn-off Switching Loss		---	1.50	---	mJ	
E_{ts}	Total Switching Loss		---	4.00	---	mJ	
C_{ies}	Input Capacitance		$V_{CE}=25V$	---	2560	---	pF
C_{oes}	Output Capacitance		$V_{GE}=0V$	---	160	---	pF
C_{res}	Reverse Transfer Capacitance	$f=1MHz$	---	120	---	pF	

Diode Characteristics ($T_c=25^{\circ}\text{C}$ unless otherwise noted)

Symbol	Parameter	Conditions	Min.	Typ.	Max.	Unit
V_F	Diode Forward Voltage	$I_F=40A$	---	2.2	3.2	V
t_{rr}	Diode Reverse Recovery Time	$V_{CE}=600V$ $I_F=40A$ $di_F/dt=356A/us$	---	186	---	ns
I_{rr}	Diode Peak Reverse Recovery Current		---	18	---	A
Q_{rr}	Diode Reverse Recovery Charge		---	2450	---	nC

Note 1: Repetitive Rating: Pulse width limited by maximum junction temperature

Typical Characteristics

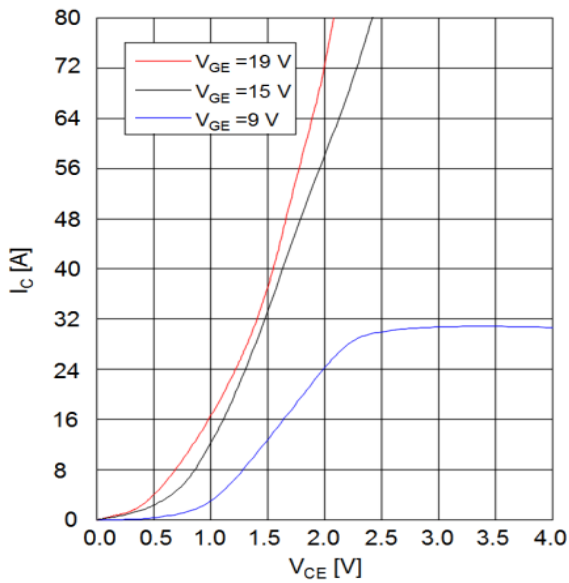

Fig. 1 Typical IGBT Output Characteristics at $T_J=25^\circ\text{C}$

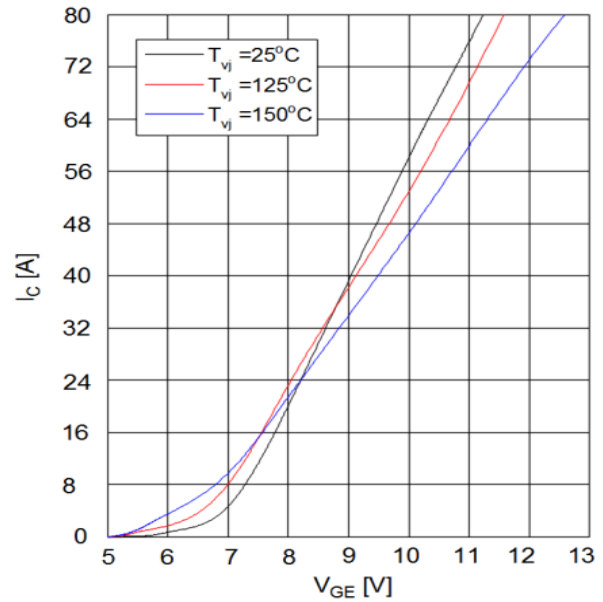

Fig. 2 Typical Transfer Characteristics at $V_{CE}=20\text{V}$

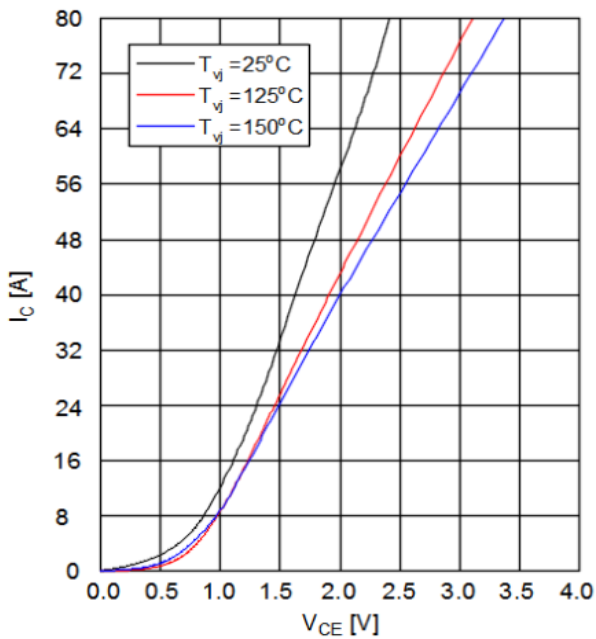

Fig. 3 Typical Transfer Characteristics at $V_{CE}=15\text{V}$

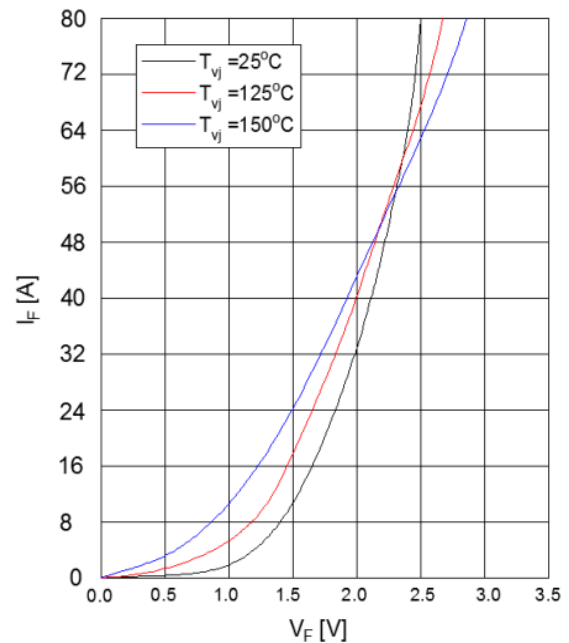

Fig. 4 Forward characteristic of Diode-Inverter

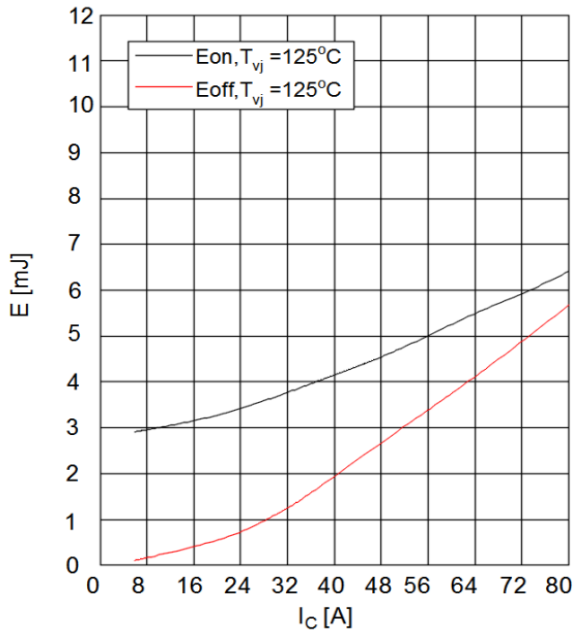

Fig. 5 Typical Energy Loss vs. I_c at $T_c=25^\circ C$, $V_{CE}=600V$, $V_{GE}=15V$, $R_g=12\Omega$

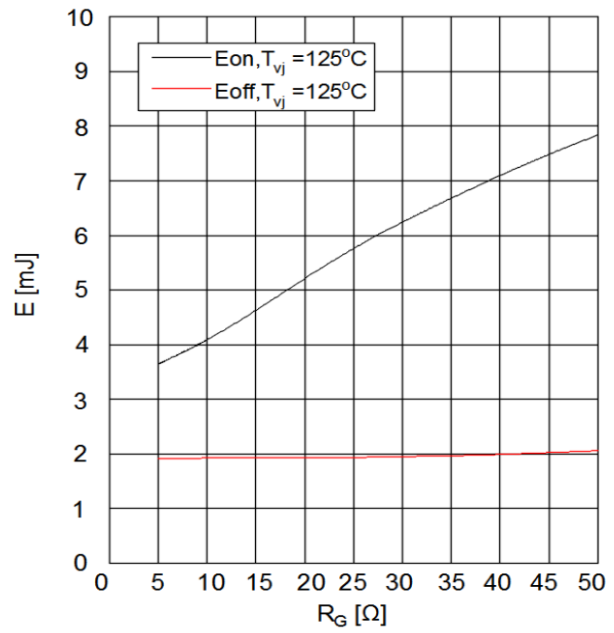

Fig. 6 Typical Switching Time vs. R_g at $T_c=25^\circ C$, $V_{CE}=600V$, $V_{GE}=15V$, $I_c=40A$

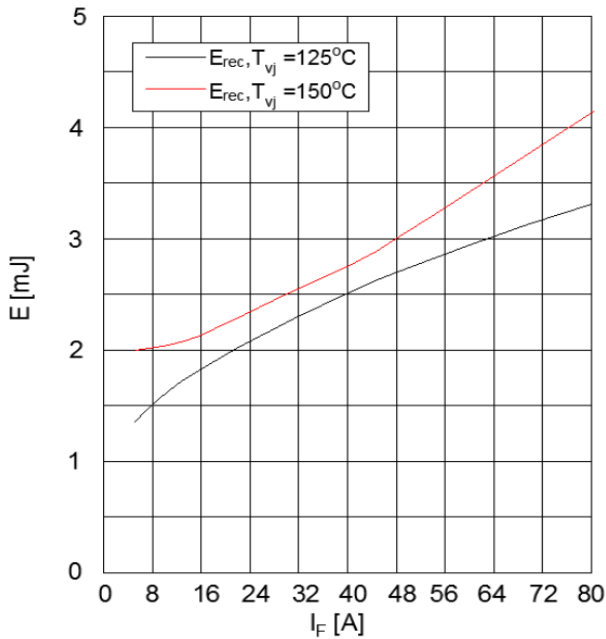

Fig. 7 Typical Diode Energy Loss vs. I_c at $V_{CC}=600V$ and $R_g=12\Omega$

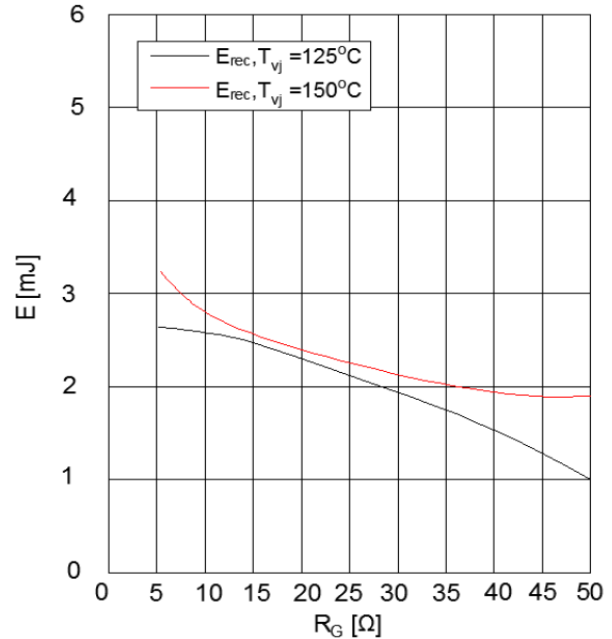
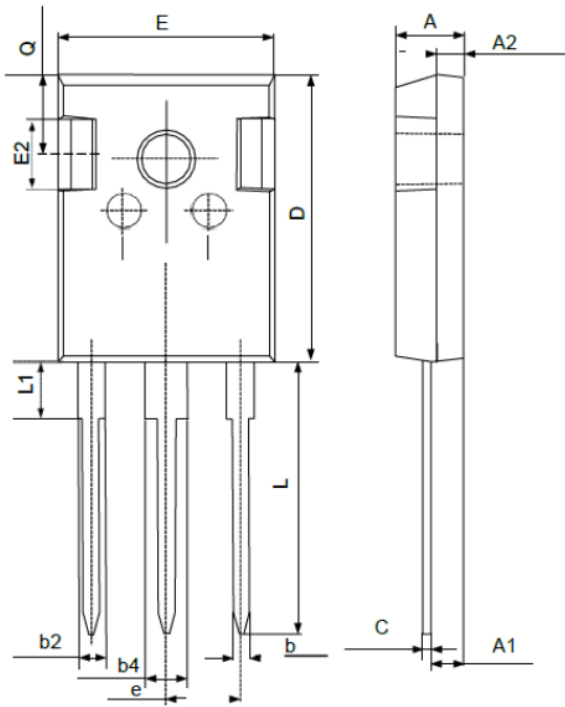

Fig. 8 Typical Diode Energy Loss vs. R_g at $V_{CC}=600V$ and $I_F=40A$

Package Information

TO-247



SYMBOL	MIN	NOM	MAX
A	4.80	5.00	5.20
A1	2.21	2.41	2.59
A2	1.85	2.00	2.15
b	1.11	----	1.36
b2	1.91	----	2.25
b4	2.91	----	3.25
c	0.51	----	0.75
D	20.80	21.00	21.30
E	15.50	15.80	16.10
E2	4.40	5.00	5.20
e	5.44 BSC		
L	19.72	19.92	20.22
L1	----	----	4.30
Q	5.60	5.80	6.00